

iNMOTION

V9

Electric Unicycle User Manual

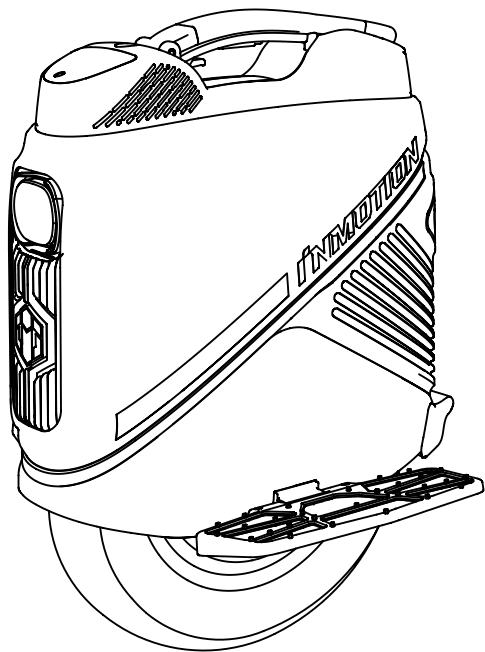

Before using your unicycle, please read the instructions, and keep this manual for ready reference.
Original instructions

I'NMOTION

GETTING STARTED

Thank you for choosing the INMOTION electric unicycle(hereinafter referred to as the unicycle)! This unicycle is an intelligent high-tech entertainment product. When you use the unicycle, there may be situations such as falling or collision that can cause injury and other risks. To reduce possible risks and ensure the personal and property safety of yourself and others, you have the responsibility and obligation to carefully read the user manual, fully understand all the warnings and precautions listed in this manual, and ensure that you can use it correctly. To obtain the latest feature/function information and safety guidance, please download the electronic version from the official website.

Important! Read carefully and keep for future reference.

Serial number (referred to as SN below) is a unique identifier for each product, which can be used for product warranty, maintenance, insurance claims, loss confirmation, and so on. The SN is a 16-character numeric code that can be found on the packaging box label, the body of the product, or in the device information section of the INMOTION App.

Get closer to your seller so he can refer you to an appropriate training organization.

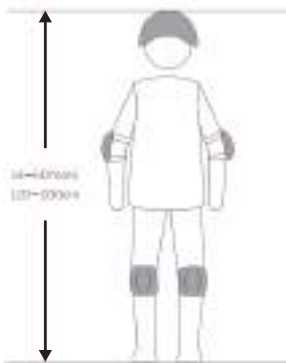

When riding an electric unicycle, please wear a helmet, knee pads, elbow pads, wrist guards and other protective gear throughout the journey to reduce the risk of injury.

All pictures in this manual are for reference only. Please refer to the actual product for accuracy.

PACKING LIST

Please carefully check all components inside the packaging. If any components are missing, please consult your point of purchase.

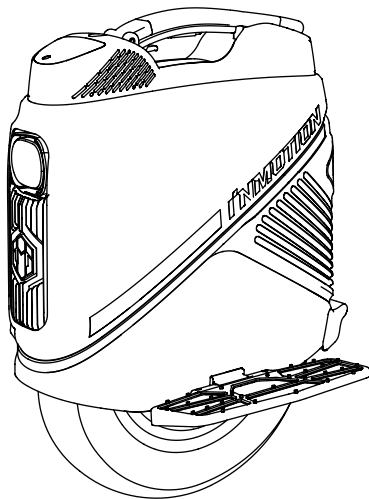

User Manual

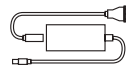

Power Cord /Adapter

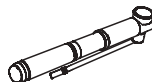

Air pump



WARNING: Please keep the packaging box and packaging materials for at least 30 days for future use when transporting the electric unicycle.

PRODUCT COMPOSITION

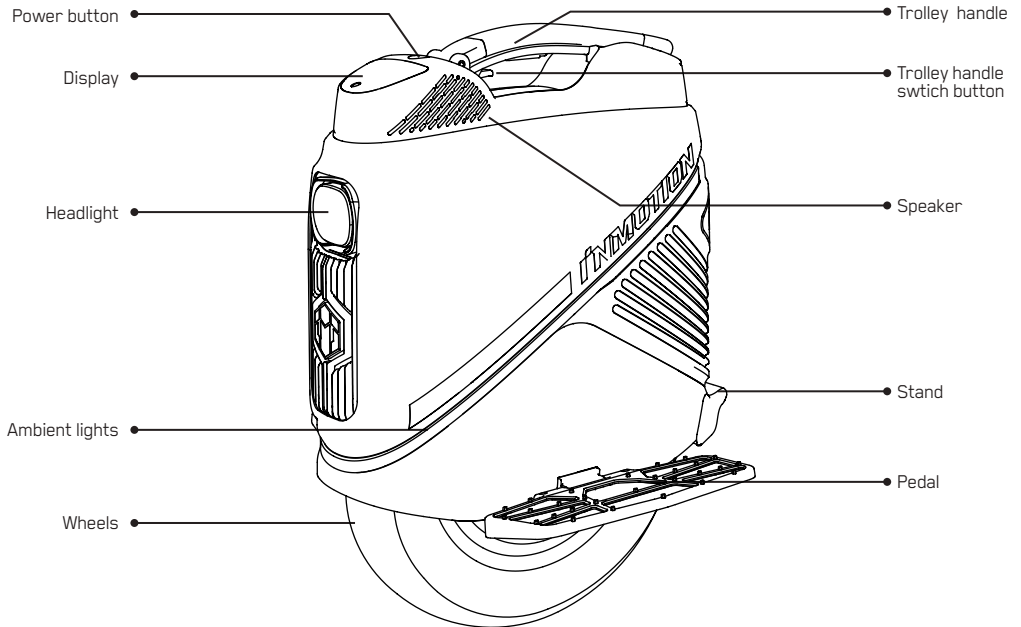

PRODUCT FEATURES

Power On/Off: Long press the power button to turn on the device, long press the power button to turn off the device when it is on.

Headlight: Short press the power button to turn on/off the headlight when it is on; the headlight can be set to turn on/off automatically in the App.

Tail Light: flashing high when braking; tail light is always on when the headlight is on.

Anti-spin Button: Press and hold the anti-flying button, the vehicle will lose balance.

Touch Screen: Get the riding data in real time and set the vehicle parameters quickly.

Charging

The original charger is 84V \approx 4A. The blue light indicates the power status, the green light indicates a full charge, and the red light indicates the charging status, indicating that it is currently charging/charging complete. When both chargers are used simultaneously, the charging time will be reduced by 50%. (The maximum input for charging the entire vehicle is 4A.)

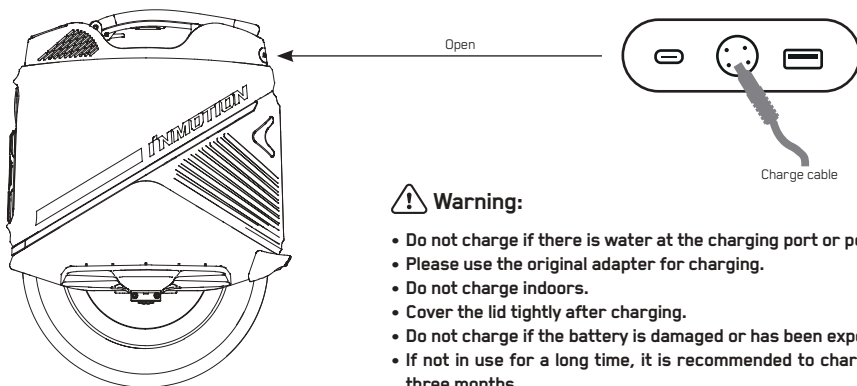

Air Suspension

Before using this product, please inflate the built-in air Suspension; otherwise, it may damage the product.

Prior to inflation, unscrew the red cap at the bottom of the footrest's air spring, then use the dedicated inflator provided with the product for inflation. Refer to the table below for the recommended air pressure. It is advisable to check the air pressure every three months.

For instructions on how to check the air pressure of the top air Suspension after using it for a period of time, please scan the QR code to watch the video.

Weight - Barometer	
Weight	Air pressure
Under 60kg	80-120psi
60-70kg	120-130psi
70-80kg	130-150psi
80-90kg	150-180psi
90-100kg	180-200psi
100-130kg	200-220psi



Scan to check out the how-to video

Shock Absorption: Equipped with dual air Suspension shock absorption function.

Note: Before use, be sure to inflate the air Suspension following the inflation instructions.

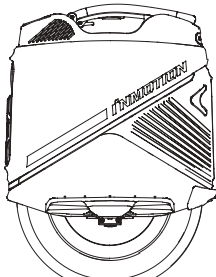

After inflating

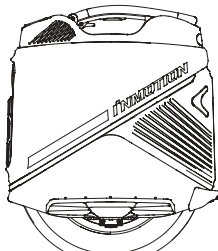

Before inflating

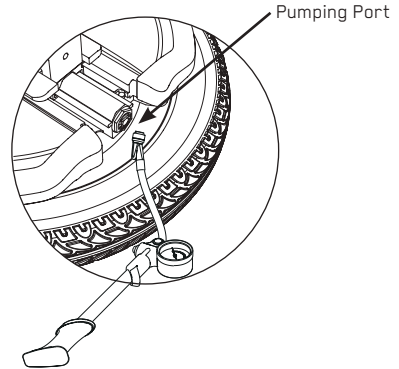

Trolley Handle

Deploy the actuator by pressing the actuator switch underneath the actuator handle to unlock it; when the actuator is not in use, hold the actuator switch underneath the actuator handle to retract it.

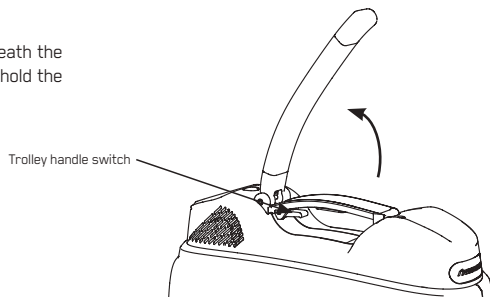

DIMENSION

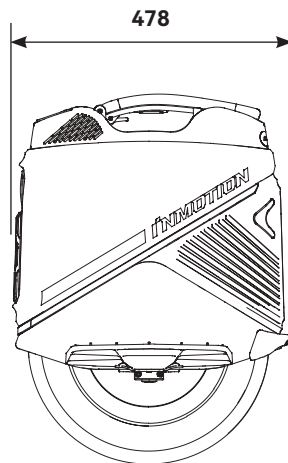
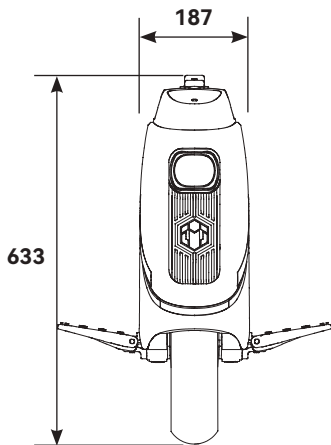
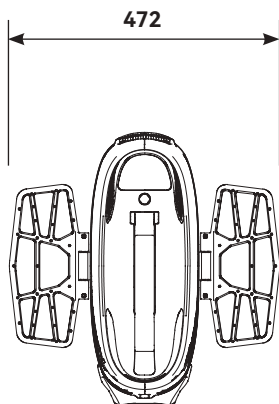

Dashboard

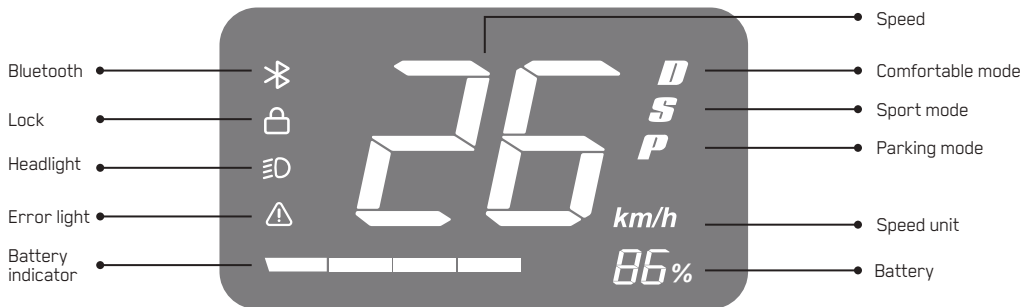

Display contents

Speed unit: Switch the display unit in the APP.

Battery level: The battery level bar and the direct number show the current battery level of the vehicle.

Lock: The APP account authenticated by the vehicle owner can lock the vehicle via APP.

Bluetooth: The icon lights up when Bluetooth is connected.

Error icon: The icon lights up when the vehicle is in fault, detailed fault information needs to connect to APP to view.

Headlight icon: The icon lights up when the headlight is turned on.

PRODUCT PARAMETERS

Specification	Item	Parameter
Basic Information	Model	V9
	Range(km)	60
	Charging time(h)	2.5h single charge
	Rated power(KW)	1
	Maximum power(KW)	2
	Designed Maximum Speed(KM/H)	40
	Maximum Climbing Angle(°)	30°
Body	Damping stroke(mm)	60
	Length*Width*Height(mm)	478*472*633
	Net weight(kg)	23
	Maximum Load(kg)	120
Battery Pack	Waterproof rating	IP56
	Rated Energy(Wh)	720
	Battery pack waterproof rating	IP67
	Rated Voltage(V)	72
	Intelligent BMS	Over-charging, over-temperature, over-discharge, over-current, short-circuit, over-voltage and other protections
Motor	Battery model	E25
	Motor Size	10inch
	Tire Size (Outer)	3.00-10
	Factory Tire Pressure(BAR)	2.8BAR
	Motor Waterproof Rating	IPX6
Charger	Charger Input (V)	84V
	Charger Output (W)	84V  4A
	Charger model	AP-PF360CH08400040
Peripheral Configuration	Charger Interface	GX16-4
	Number of charger ports	1

Specification	Item	Parameter
Lighting Configuration	Automatic headlights	Yes
	LED Daytime Running Lights	12W
	Illumination Lamps	1W
	Tail light-brake light	Colorful strips on both sides
Requirements	Ambient light	16-55
	Applicable height(cm)	120-200
	Operating Temperature(°C)	-10-45
	Storage temperature(°C)	-20-45

[1]: Typical range is obtained at full charge, with a load of 90kg, ambient temperature of 25°C, and riding at speeds of 20 to 40 km/h on a flat, paved road. The range of the wheel is influenced by factors such as temperature, tire pressure, road conditions, and riding habits (such as rapid acceleration and braking).

[2]: fully charged, 90 kg payload, 25°C, no wind, at the flat road.

[3]: fully charged, 90 kg rider get the data through a large amount of tests.

INITIAL USE

Before Use

Electric Unicycle is a high-tech recreation product. When you ride without following the operation specifications, it may lead to unpredictable injuries and property losses. The following will explain how to use Electric Unicycle and the precautions in details. Please read it carefully and use Electric Unicycle as required. Before using, please make sure that all parts of Electric Unicycle are not damaged and installed properly.

Warning:

- Before using the Electric Unicycle, ensure that the battery is fully charged. It is recommended to charge it more than 80 percent of capacity.
- Find a relatively open and flat area to practice riding, (at least 4m by 4m in area), both inside and outside. You need to be fully aware of the riding environment around you to ensure that you are not disturbed by obstacles such as cars, pedestrians, pets, bicycles, etc.
- You need a skilled assistant stood by. The assistant must be familiar with Electric Unicycle and all precautions and usage methods in this manual.
- Please do not ride the vehicle on slippery ground.
- Users are advised to wear comfortable, casual or sports clothing, and to wear flats and warm up to improve your flexibility.
- Be sure to wear a helmet and riding protective gear to avoid injury.

Download INMOTION App



Download the App in the following ways

1. Scan the QR code on the left
2. Search "INMOTION" in the Apple store or Google Play Store.
3. Visit www.inmotionworld.com/support/app

Tips:

Electric Unicycle supports Bluetooth 5.0 BLE. The BLE ID is E25-XXXXXXX, where XXXXXXX is the last 8 digits of SN.

Install the INMOTION App on your mobile device (iOS 12.1 and above or Android 7.0 and above supported) and follow the prompts to connect your Electric Unicycle.

For more functions, please visit the official website to download the latest version of INMOTION App user manual.

LEARNING TO RIDE

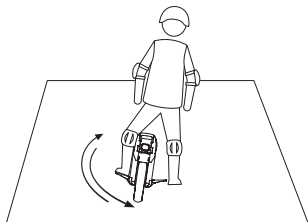

1. Step on the pedal with one foot, then swing back and forth.

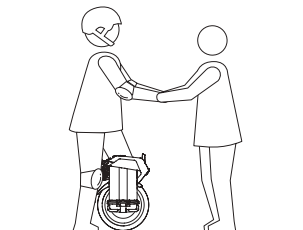

2. Step on the pedal with one foot, keep your feet and body upright and gradually shift your weight up.



3. Step on the pedal with one foot, lift the other foot off the ground for 1-2 seconds and start gliding.

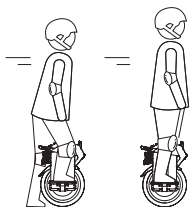

4. Step on the pedal with one foot, push back with the other foot and start gliding.

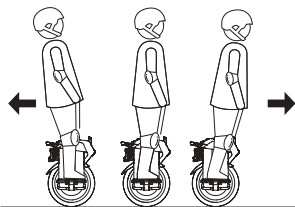

5. Step on pedals with both feet, use your weight to move forward and back.

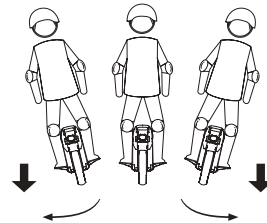

6. Press the pedals with feet by different force to make a turn.



INMOTION App



Facebook group



Website