

DYU SMART ELECTRIC BIKE A5

INSTRUCTION

Do not use this product without carefully reading this instruction manual
and understanding the performance of electric bicycles

Please keep the instruction manual properly



By F-Wheel

PRODUCT FUNCTION DIAGRAM

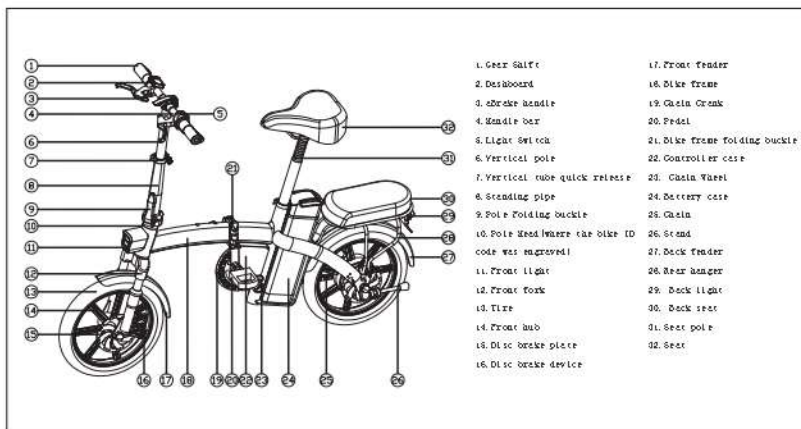

Note: Due to the company's product upgrade, some details of the product you get may be different from this picture, but it will not affect your normal use.

PARTS LIST

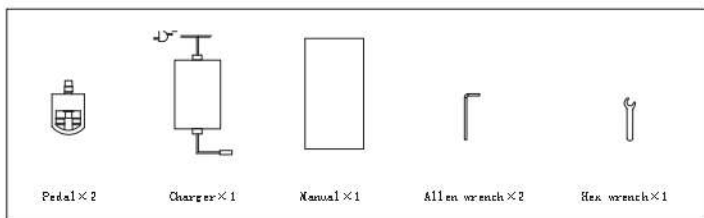

Folding Picture:



1. Lower the seat then lock it 2. Fold the vertical pole 3. Fold the bike frame

Install the pedals:

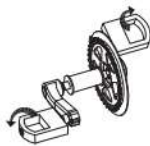

Right Foot pedal:
rotate clockwise to install

Left Foot pedal:
rotate counterclockwise to install

FUNCTION INTRODUCTION

1. Install the handlebar after unpacking, straighten and release the quick-release handle, adjust the horizontal handle to the appropriate direction, then press the quick-release, gently hold the brake lever a few times, and use it after the brake line returns to the best state, then install the foot pedal.
2. Charging: Connect the charger and start charging. When the indicator light of the charger changes from red to yellow-green, continue charging for one hour more.
3. Switch on and off: Lightening button on the wireless key, press it twice in rapid succession, hear the alarm sound once, then you can turn on, the instrument will start to work. After turning "Unlock the " key on the wireless key, or lock the " key, press once to hear the alarm sound twice, you can shut down, the meter stops working after shutdown.
4. Turn on the anti-theft/release the anti-theft: Press the lock key on the wireless key to turn on the anti-theft. In this state, when the car is shaken, an alarm will sound. Press the unlock key to release anti-theft. In this state, the car will not emit an alarm sound when it is vibrated.
5. Bike seat/sensitivity: Press the ringing key on the wireless key, and the anti-theft device will ring 5 times at intervals to facilitate car search. You can press other keys to stop the chirping. Long press ring. Press the button for 5 seconds to adjust the vibration sensitivity, one ring for high sensitivity, two rings for medium sensitivity, three rings for low sensitivity, continue to long press the ringing key to switch cyclically.
6. Power indicator: There are four levels of power indicator on the meter. For details, please refer to the instrument function introduction.
7. Horn: Switch on the left side of the handlebar. After pressing the horn button, the horn starts to sound. It is recommended to click. If you continue to press the horn button, the horn will stop automatically after 10 seconds. Please release it before using it.
8. Headlight: ON/OFF on the left side of the handlebar is a light switch.
9. Brakes and tail lights: The brakes cannot be accelerated when the brakes are not fully rebound. The night running lights and the front lights are switched synchronously. The brake lights are bright when braking.
10. Electric and power-assisted: The maximum speed of electric is 25km/h (the load, road conditions and power state are different). The default ECO economical gear for power-on boot can be switched to three gears in a cycle. For details, please refer to the instrument function introduction. Any gear can be directly driven by the accelerator.
11. Cruise at fixed speed: When driving electrically, rotate the accelerator for 3-8 seconds and release it. You can drive at a constant speed at the current speed. Rotate the accelerator or brake again to cancel the cruise at fixed speed.
12. Battery Removal and Installation: Press the lower handle behind the seat cushion, turn the seat cushion forward,

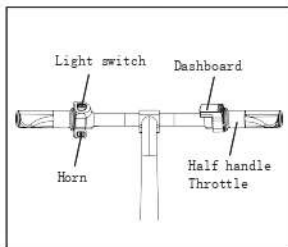
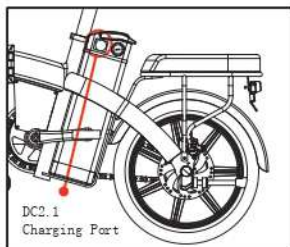





See below meter screen:





INTRODUCTION TO METER

INTRODUCTION TO THE ICONS ON METER INTERFACE





Definition of Display Icon	Display Icon	Display
Front Light		When the front light is turned on, this icon is always luminous. When the front light is turned off, it will be lightless. (The users can take this function for reference when pressing the button on meter to turn on or turn off light. Other operations to turn on or turn off light is subject



Current Mileage		It displays the current mileage from start-up, from 0.0 to 9999KM. Less than 1000hours, mileage displays 0.0 to 999.9KM. More than 1000hours, mileage displays 1000 to 9999KM.
General Mileage		It displays general mileage, from 0.0 to 9999KM. Less than 1000hours, mileage displays 0.0 to 999.9KM. More than 1000hours, mileage displays 1000 to 9999KM.
Current Speed		It displays the current speed.
Current Power		It displays power range.

FUNCTION OF BUTTON

Name	Icon	Description
Power Button		Press the power button to turn on the E-bike. Keep pressing the power button to turn off the E-bike.
Functional Button		Functions of this gear button: ECO means energy-saving mode; MID means medium grade. HIGH means high grade with circular switch.
Adjusting Button		000, TRIP, Voltage, Failure Code and Circular Adjustment Display.

ELECTRIC INSTRUCTION

Power Percentage	> 70%	50%~70%	30%~50%	< 30%
Display				

When the battery power less than 30%  , the power meter will monitor if the power level is less than low-voltage protection standard. After the power meter has detected that power level is lower than low-voltage protection standard, the icon  " will keep flashing, which warns a battery low-voltage.

FAILURE CODE

Under the Failure Code mode, the current failure code will show up flashing. Please check below description of failure code:

- "EE-1" means that the meter fails to receive the communication signals.
- "EE-2" means that the meter fails to send the communication signals.
- "EE-3" means that the control board fails.
- "EE-4" means that Hall sensor fails.
- "EE-5" means default phase fails.
- "EE-6" means gear shift handlebar fails.
- "EE-7" means that brake handlebar fails.
- "EE-8" means assistant sensor fails.
- "EE-9" means the motor under low-voltage protection.

PRODUCT PARAMETERS

	Material	Aluminium alloy
Size	Folding size	730*330*650mm
	Released size	1275*520*1001mm
	Center distance of front and rear wheels	895mm
	Height between pedals to ground	120mm
	Hub size	14inch
	Package size	1190*220*650mm
	Color	Black/ White/Red
Performance	Weight	(7.5Ah)22.4KG / (21Ah)24.4KG
	Max load	120kg
	Riding speed	<25km/h
	Mileage	(7.5Ah):around 40KM / (21Ah):around 110KM
	Uphill	15 degree
	Temperature	-10°~45℃
	Waterproof	IP54
Standards	Battery	7.5Ah or 21Ah lithium battery
	Battery rated voltage	DC48V
	Charging voltage	DC54.6 V
	Charger input voltage	AC220V
	Charging time	4H/11H
	Motor type	Brushless DC motor
	Motor rated power	550W
	Motor rated power	48V
Features	Seat height	Adjustable
	Suspension	Front fork suspension and seat pole suspension
	Lights	Yes(Front and rear light)
	Brake mode	Front and rear disc brake
	Smart App	No

Remark: Many factors will affect the max speed, such as power, load, tyre pressure, road conditions, chain, lubrication degree etc. Mileage has been measured on basis of temperature 25℃, load of 60KG, speed of 15-20KM/H, smooth and hard road, and from full battery to dead battery. It also is subjected to other factors, such as driving habits, temperature, load, tyre pressure, road conditions etc. "

CIRCUIT SCHEMATIC

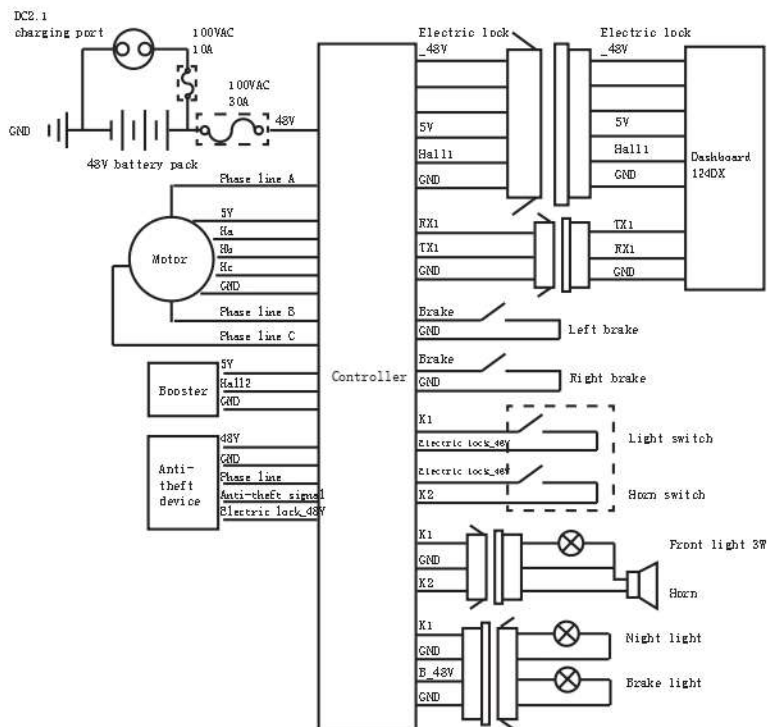

ILLUSTRATION OF BATTERY REMOVAL AND INSTALLATION



1. Press the lower handle behind the seat cushion and turn the seat cushion forward;
2. Unplug the power cord and unlock the battery key;



3. Lift the battery along the direction of the chute to disassemble;
4. Reverse operation can complete the battery installation.

CAUTION

Charge between 0 degree-45 degree, rife between -20 degree to 60 degree, keep the battery dry. Don't put it in acid and alkalinity Fluid. No rain, Fire and heat. Don't put the battery positive an negative wrong. Don't damage disassemble the battery or use the wrong adapter. Don't charge it over 6 hours and don't charge it over 2A.

When not using for a long time, please put the battery in dry and cool place and charge it for 2 hours every 2 months. Follow the instruction or the user will be responsible for the consequence.

When charging, Please be careful of the battery type and voltage, place the battery in open air and don't put it under bright sun shine and closed space.

When charging, please place the battery first, then connect the electricity; after charging, cut the electricity then cut the battery plug. When the green light lights up, turn off the power, don't connect the battery when not charging.

When charging, if the indicating light goes wrong or some strange smell shows up or the charger is over hot, please stop charging immediately, then check and repair or replace the charger. When using or storing the charging. In case of something wrong were dropped into the charger, especially the water or other fluids, please don't take the charger when possible. Otherwise, be careful and put it in the cool box. No disassembling the charger yourself.

Please check the brake before riding.

Please brake the rear wheel first.

Be careful of the tightness of brake, use the hexagon wrench when it's loose.

Rainy and snowy days need longer braking distance.

Suitable age :16-45 years old.

Riding

Read the instruction first to know the product performance first.

Don't lend it to someone who is not familiar with it.

Wear a helmet when riding. Obey the traffic rules and don't ride it in the cars road. Don't riding it in the crowded road.

When go downhill or slippery road, the speed should be under 15km/h.

Inspect the Tyre before riding, Tyre pressure should be 35-45PSI.

Don't over impact the motor, keep the axle smooth.

Don't over load. (Max load is 120kg)

Please be careful of the adding distance when it under the rainy day and snow day.

Single-handed ride is prohibited.

Maintenance

The E-bike front and back wheel should be at the center of the frame.

Put the E-bike up after riding at cool and dry place.

Check the Motor and Brake often, don't inject the oil onto the brake.

Check the E-bike and screws and places that need fixing, fix it often.

Suggested torsion: Bar screws 60-80 kgf.cm, bar stand screws 175-200kgf.cm, wheel screws 320-450kgf.cm.

Check the Tyre is pierced and leaks air, please contact professional technician for repairing and replacing.

Responsibility announcement

All the product model, type and related information copy right and explain right are reserved.

This instruction is suitable for denoted models.

Any changing or replace part of the E-bike will not be informed again.

No copy, modification, propaganda or publication before getting the permission form E-wheel.

Read the instructions and follow the instructions or the user will be responsible for the damage.

Manufacturer: Shenzhen Counterbalance Technology Co., Ltd.
Production address: No. 105, Pingshan Industrial Road, Tangxia Town, Dongguan City, Guangdong Province
website: www.futeel.cc
Phone: 086-0755-21006876