

Ride The Future /

www.79bikes.com

 79BIKE

FALCON PRO

OWNER MANUAL



The number 7 symbolizes luck and success,

while 9 represents lasting achievement.

Our logo merges '7' and '9' into a chip design,

reflecting how smart technology turns every ride into a unique adventure,

pushing riders to exceed their limits.

79bike, designed for young off-road and extreme sports enthusiasts,

features "Pioneer Purple," symbolizing strength,

innovation, and transformation.

It represents freedom, fearlessness, and creativity,

inspiring riders to boldly explore new possibilities

and embrace the unknown

Who We Are

We are 79Bike, a young brand focused on electric off-road motorcycles. We are dedicated to providing a unique adventure experience for young riders.

Our Vision

79Bike's vision is to become the world's leading electric off-road motorcycle brand, offering riders globally thrilling and unforgettable adventures.

Our Commitment

We are committed to delivering durable and reliable products, continuously innovating to offer riders more exciting experiences while contributing to environmental sustainability.

Our Philosophy

We believe that adventure should be free and ever-evolving. We aim to provide riders with a stage where they can rediscover themselves, start anew, and continually push their limits, challenging the extreme.

Welcome	01
Important label Position	02
Safety Instructions	03
Driving environment requirements	04
Pre-driving Inspection	05
Driving Instructions	06
Instructions for use	06
Functional Diagram	07
Dashboard Information	08
Button Functions	09
Model Parameter Table	10-11
Other Statement	12
Vehicle electrical schematic diagram	13
Preparation Before Riding	14
Mobile App Pairing	14
Check tires	14
Check the dashboard、Horn、Brakes	14
Check the handlebars	14
Shock absorber adjustmen	14
Vehicle Usage Instructions	15
Vehicle "Power Cut" (Power is on, but the vehicle loses drive)	15
Vehicle Power Reduction	15

Operating Conditions	16
Water Exposure Guidelines	16
Fault Phenomenon And Troubleshooting Method	17-18
Maintenance Guide	19
Check content	19
Inspection of operating parts	20
Battery inspection	21
Battery charging and charger usage	22
Use and maintenance of motors and controllers	22
Replace of fuses	23
Daily Use Instructions	25
After-sales Service And Warranty Service	26
After-sales Service And Warranty Coverage	27
Warranty rules	27
Warranty start date	27
Non-warranty Coverage	28
User's own Regular Maintenance Table	29
Regular Maintenance Record Card & Warranty Record Card	30
Packing List	31-32

WELCOME

Thank you for choosing 79BIKE electric off-road motorcycle, this product complies with the national product enterprise standard.

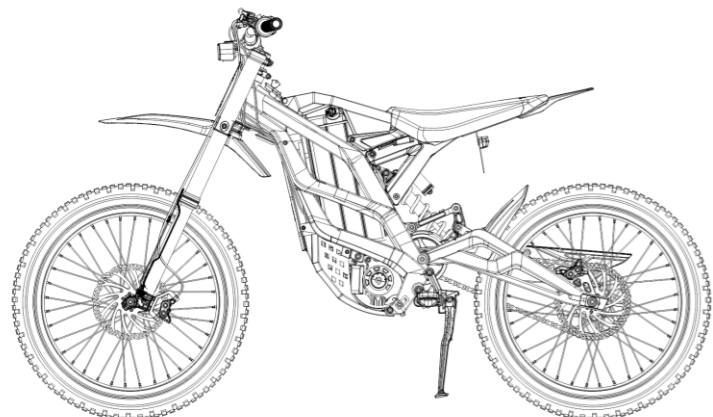

Vehicle Vin Label

In order to ensure your driving safety, please read this instruction manual carefully before use and keep it in a safe place. Do not ride this product until you know how it will perform.

Do not use it until you are familiar with the performance, operation, and maintenance of the vehicle. All pictures in this manual are for reference only, please refer to the actual product.

The pictures in this manual are for reference only, please refer to the actual product for appearance and function.

Important label position

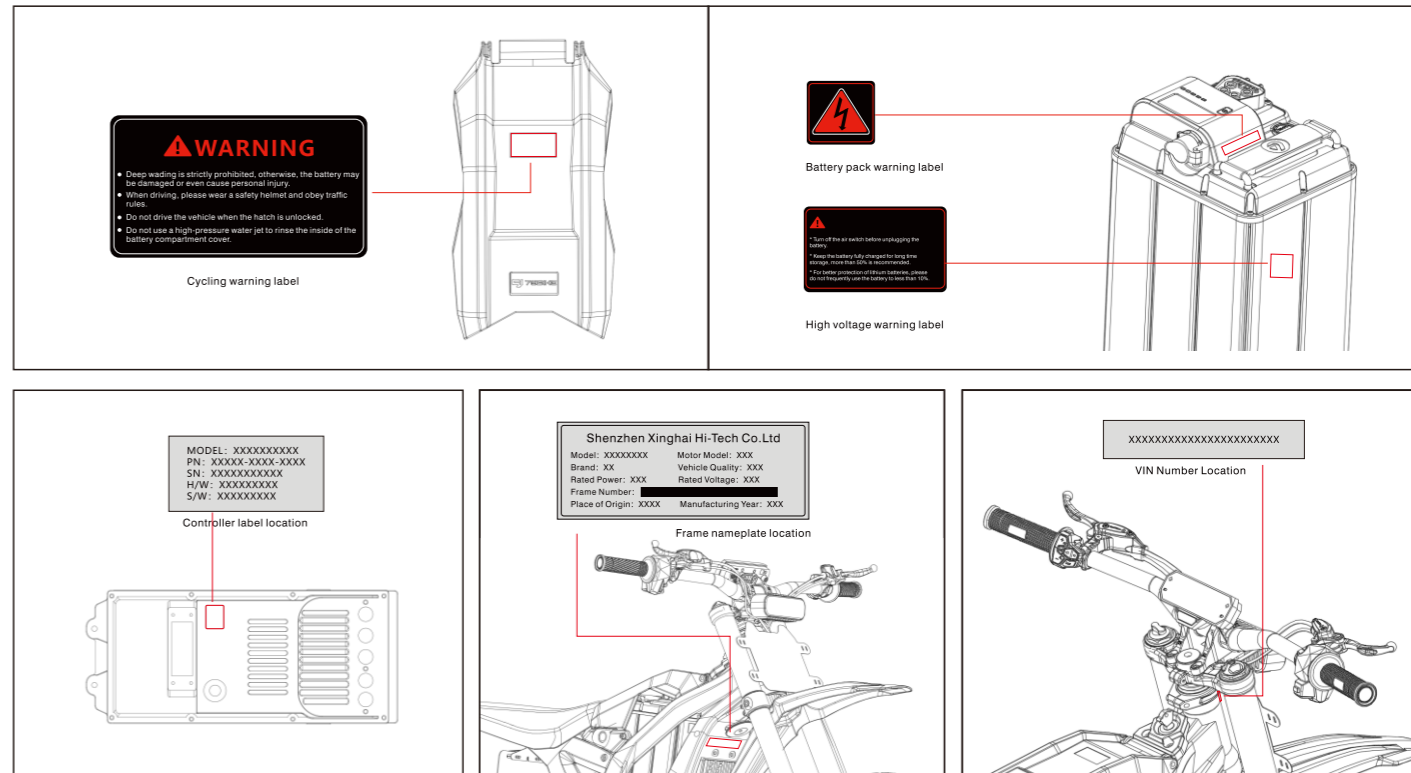

1、SAFETY INSTRUCTIONS

- ◆ Persons under the age of 18 are strictly prohibited from driving this product.
- ◆ According to local laws and regulations, it is strictly forbidden to drive in public places or on motorways.
- ◆ You must be aware of the laws in your area and comply with the relevant laws and traffic regulations.
- ◆ Before using this product, it is recommended to have the necessary motorcycle driving license or professional training and proficiency in motorcycle driving skills.
- ◆ Before you drive, please be familiar with the contents of this manual, and then find an open and safe place to practice, to fully grasp the driving essentials of the vehicle and be familiar with its structure, this is the foundation of safe driving.

- ◆ Be sure to wear proper quality helmets and protective gear when riding.
- ◆ Charging should be kept away from combustible materials and the charging time should not be too long.
- ◆ This product contains many electrical parts, please do not stay in the rain for a long time.
- ◆ This product can only ride one person, so please do not carry people or items.
- ◆ Do not park in building foyers, evacuation stairs, walkways and fire exits.
- ◆ Do not lend this product to persons unfamiliar with it to avoid injury. Please read this instruction manual carefully before using this product.
- ◆ When riding, please wear brightly colored clothing, need to move the whole body freely, not tight, cuffs do not open, do not wear slippers or high heels while driving.

- ◆ Note: Please remove the battery when washing the vehicle. do not use a high-pressure water gun to flush the battery or other electrical parts!
- ◆ If this product sends an abnormal sound or alarm, please stop using it immediately and contact the after-sales service phone for professional guidance or maintenance services.
- ◆ Do not immerse the battery in water (damage to the battery's appearance will damage the waterproof performance of the battery). The vehicle wading should not exceed the wheel center, otherwise, it may cause the battery water, internal short circuit, the battery fails permanently or even explodes.

 For your safety, please do not modify this product, if you need to replace parts, please contact after-sales service.

Driving environment requirements

- ◆ Do not drive in bad weather or when you are extremely tired. Rain, snow riding, the braking distance will be extended; Heavy rain and other inclement weather, try to avoid going out.
- ◆ Please drive slowly and carefully in difficult road conditions. When high-speed driving this product over obstacles, uneven ground, slippery road surfaces, material evacuation ground, steep slopes, or sharp turns, you may lose control of your vehicle resulting in a collision, fall, or injury.
- ◆ Please avoid riding in heavy rain or waterlogged roads. When the water on the road exceeds the center of the wheel, it may affect the work of the motor and brake. The vehicle can be used in rain and snow, but it is not allowed to wade deeply for a long time. It is recommended that the wading depth should not exceed 20cm.
- ◆ Before using this product, it is recommended to have the necessary motorcycle driving license or professional training and proficiency in motorcycle driving skills.
- ◆ The operating temperature of the product is -10~45°C and the storage temperature is -10~50°C; The recommended storage temperature is 10 to 30°C. Do not store or drive outside the temperature range.

Driver requirements: (The following personnel should not drive this product)

- 1) Personnel under the age of 18
- 2) Pregnant women or persons who are unable to engage in strenuous physical activity due to illness
- 3) Persons under the influence of alcohol or drugs
- 4) Persons exceeding the prescribed weight limit

Pre-driving inspection

- ◆ Axle screws are not loose.
- ◆ Check the tire: the tire is not cracked, with no abnormal wear; No nails, stones, glass, and other foreign bodies embedded.
- ◆ For normal riding, the tire pressure should be 32.6 psi (225 kPa).
- ◆ Check the fixing of the handlebars and front and rear wheels: ensure that the handlebars are stable, the front and rear wheels are stable without shaking and can run normally.
- ◆ Check reflectors for damage or contamination.
- ◆ Check the status of the power supply circuit, lighting circuit, etc., to ensure normal operation.
- ◆ Check that the front and rear braking systems are working properly.
- ◆ Ensure that the power supply meets the riding requirements.
- ◆ Spoke tightness: tighten immediately if loose (4N·M-6n·m).
- ◆ The accelerator is smooth without stuttering, and returns quickly.
- ◆ The fork's inner tube is clean and free of dirt.
- ◆ The rear shock inner tubes are clean and free of dirt.
- ◆ Belt status: If there is any abnormal sound, you can use a belt silencer, and if there is any foreign matter, please remove it.
- ◆ Chain status: 1-2cm floating space in normal chain condition. If stuck, it is recommended to clean the sand and add lubricating oil.
- ◆ The front and rear brakes can brake normally, and ensure that the brake lines are not damaged.

Driving instructions

- ◆ To avoid distraction, do not use cell phones, cameras, headphones, earbuds, etc. while driving this product.
- ◆ When you are eager to experience 79BIKE off-road motorcycle, it is recommended that you experience in a closed safe place, and wear the relevant protective equipment, do not drive in public places or on motorways.
- ◆ Avoid rapid acceleration and deceleration to save electricity, protect vehicle body components, and improve mileage and vehicle life.
- ◆ If any abnormality occurs while driving, please stop driving immediately. Do not use this product until the cause of the abnormality is found and repaired. Please contact the after-sales service in time.

Instructions for use

- ◆ When the vehicle is not in use, park the product on a flat surface and turn off the power. Otherwise, it may lead to skidding and bring harm to you and the people around you. Do not park the vehicle on an inclined or soft ground to prevent the vehicle from tipping over!
- ◆ Be sure to use the vehicle's special lithium battery charger. The charger input voltage is 110-240V. Stand the product before charging. If the charger and charging port are wet, do not charge. Do not charge or park in the forbidden area. Keep away from combustible materials when charging, and cut off the power supply immediately after charging.
- ◆ Do not charge the battery below 0°C, otherwise it will damage the battery. Wait for the battery temperature to return before charging.

2、FUNCTIONAL DIAGRAM



⚠ Note: When the temperature of the driving motor, the motor controller is too high, or the battery power is too low, the vehicle will automatically reduce the power to run, which is not a malfunction.



⚠ Note: For the convenience of maintenance, overhaul and service, each vehicle has a unique frame number and motor number, please protect it properly. The frame number is engraved on the front of the bike, on the side of the frame riser. The motor number is engraved on the drive motor body.

Dashboard Information

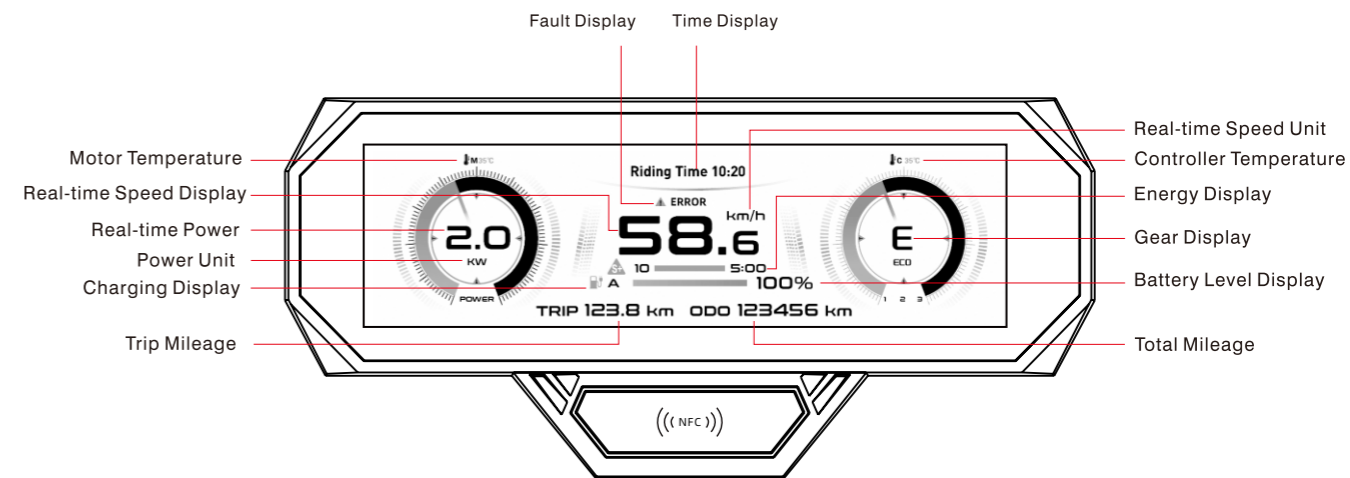

1、Fault code

E2: Transfer fault E3: Communication fault
E6: Over-voltage E7: Motor sensor fault

E4: Hardware overcurrent protection E5: Under-voltage
E8: Locked rotor protection

2. Gear Explanation (Note: E, D, and S modes can be cycled through by a single press.)

E: Speed limit 40km/h D: Speed limit 80km/h S: No speed limit
 R: Reverse P: Parking gear N: This gear is neutral

3. Button Descriptions

Buzzer button: Click the buzzer to pass through;

High and low beam button: Press and hold for 2-3 seconds to turn on/off the headlights, click to switch between high and low beams;

Left and right steering button : Single button click is for left and right steering. In the setting mode, it is for up and down page turning, addition and subtraction;

R button: press to switch mileage, press and hold to enter reverse gear, release to exit reverse gear ;

M button: Click to switch gears, press and hold for 3 seconds to enter the setting menu, single click on the setting page as the confirmation key, press and hold this button to exit the menu.

Button Descriptions

Click this button and hold for 3 seconds to enter the setting menu. In the setting page state, single click is used as the confirmation key. After the setting is completed, press and hold this button to exit the menu.

Hold press to turn on/off the light, click to switch between high and low beams

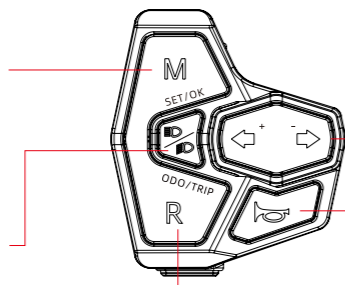

Clicking a single time is for left and right steering. In the setting mode, it is for page turning up and down, addition and subtraction.

Click to send the buzzer signal

Press to switch mileage, press and hold to enter reverse gear, release to exit reverse gear

3. MODEL PARAMETER TABLE

Performance index	Project	79 BIKE-PRO
Basic information	Brand	79 BIKE
	Vehicle size (L × W × H)	1870X755X1088 mm
	Vehicle weight (including battery weight)	59.2kg
Riding requirement	Maximum load	120kg
	Applicable age	18~55 years
Main vehicle parameters	Wheelbase	1250mm
	Height of seat	830mm
	Minimum ground clearance	275mm
	Maximum speed	>85KM/H
	Maximum power	8.5KW
	Full battery range	120KM (25KM/H)
	Maximum torque	410N.m
Battery	Protection level	IP67
	Battery type	Ternary lithium battery
	Nominal capacity	35Ah
	Nominal voltage	72V
	Battery charging current	10A
	Charging time	3-4H
Electric machine	Motor type	High speed permanent magnet synchronous motor
	Rated power	5KW
	Rated voltage	72V
	LED Light (Star ring)	LED intelligent adjustment

Performance index	Project	79 BIKE-PRO
Recharger	Input voltage	AC110/220V-50/60Hz
	Output voltage	84V
	Output current	10A
Controller	Specifications and models	72V sine wave vector control
Vehicle body system	Frame design	Aluminium alloy forging
	Wheel type	Spoke wheel - Aluminum alloy 19*1.4
	Tyre type	Off-road tires -70/100-19
	Primary drive system	HTD 8M belt 560mm+20mm Width
	Secondary drive system	420 chain 106 knots
	Suspension system	Fully adjustable shoulder shock absorption - travel 200mm
		Multi-link fully adjustable external airbag hydraulic shock absorber - stroke 85mm
	Front brake	203mm*2.3T
	Rear brake	203mm*2.3T
	Handlebar specification	760mm
	Communication port	RS-485 + CAN
Lighting system	Full LED low beam + high beam (black) + turn signal + brake light	
Other	Instrument type	TFT HD Display
	Phone charging port	Type-C
	Fall sensor	have
	kickstand sensor	have
	NFC	have
	NightRiding mode	have

The cruising range value will vary greatly due to different test environments. The battery life of the road test is the actual measured data of the product when the rider weighs 75kg, the ambient temperature is 27°C, and the speed is 40km/h.

4、OTHER STATEMENT

- 1) To the extent permitted by law, the company reserves the right to interpret and explain this statement.
- 2) The company is committed to continuously improving product functions and performances. Later product specifications and manual content may be changed accordingly without prior notice, please understand! If there are differences between the icons, pictures, etc. in the manual and the actual product, please refer to the actual product.
- 3) The company shall not be liable for all claims, responsibilities and losses caused or may be caused by consumers' violation of the above statement. Unforeseen or unavoidable risks encountered during driving shall be borne by the driver himself.
- 4) If one day you want to resell or give away your 79 BIKE cross-country motorcycle, please don't forget to pass along this manual, because it is a part of the product. If you have any questions to consult, our company is glad to serve you at any time. Thank you again for your choice and trust in this product.

Attachment: Vehicle electrical schematic diagram

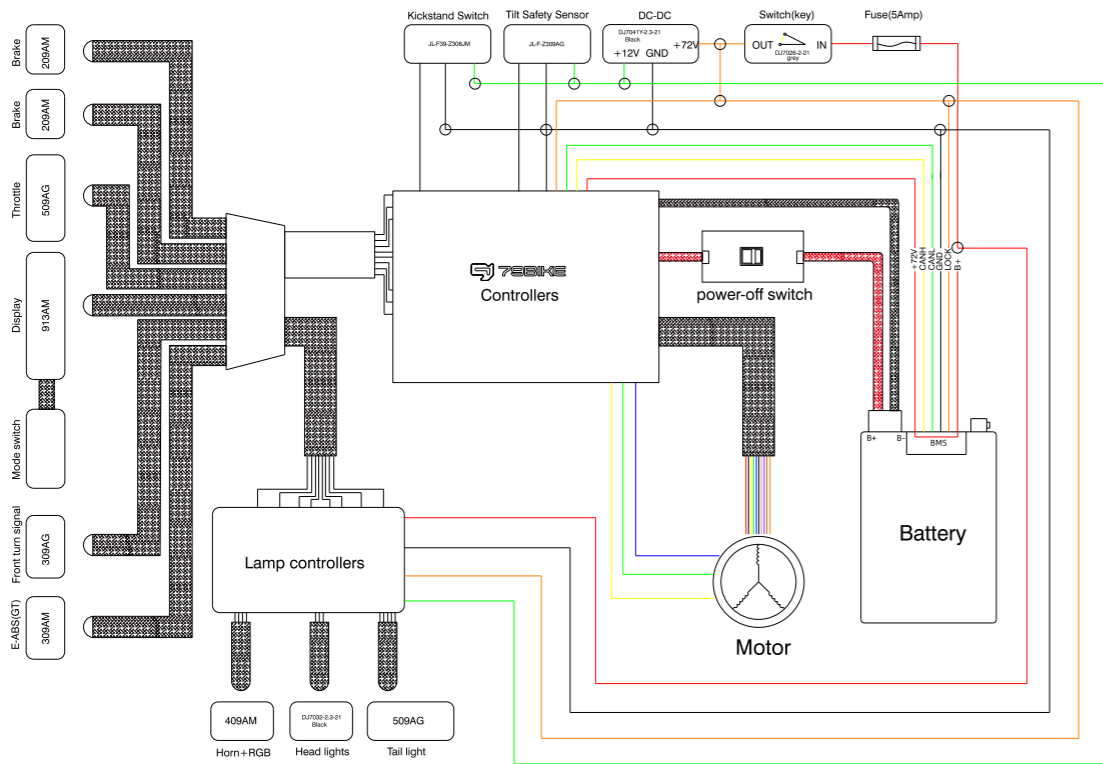

5、PREPARE BEFORE RIDING

Mobile App Pairing

- ◆ Android system please search for "Tuya Smart" in the app store to install.
- ◆ For Apple ISO system, please search for Tuya Smart in the App store to install it.



Check the tire

- 1) The tires are intact.
- 2) The normal tire pressure is 32.6 psi (225 kPa). Insufficient tire pressure can lead to abnormal wear, poor steering, low driving speed, and short range.
- 3) Excessive tire pressure will lead to abnormal wear, poor comfort, and even a burst tire, resulting in safety hazards.

Check instrument panel, horn, brake

- 1) Check whether the function display of each part of the dashboard is normal.
- 2) Check whether the horn is working properly.
- 3) Hold the left and right brake handles respectively to check whether the front and rear brakes work normally.

Check the handlebars

Handlebars need to be fixed, reliable and steering flexible.

Shock absorber adjustment

Adjust the front and rear shock absorption according to the actual situation.

6、VEHICLE USAGE INSTRUCTIONS

Vehicle "Power Cut" (Power is on, but the vehicle loses drive)

- ◆ Battery dead
- ◆ Motor overheating
- ◆ Controller overheat
- ◆ Battery overheating
- ◆ Tipping power failure (cut power output after 3 seconds of vehicle tipping)
- ◆ Power off of the foot brace (when the foot brace is supported, there is no power output by twisting the throttle handle)
**When the air switch is off, there is no power output by twisting the throttle knob.*

Vehicle Power Reduction

- 1) When the battery power is less than 15%, the controller will reduce the output power to protect the battery.
** Due to the characteristics of the battery, the meter display may be inaccurate.*
- 2) When the power is less than 5%, if there is a large load (such as urgent refueling or steep slope, etc.), the controller may enter undervoltage protection and the vehicle will stop running. If you don't charge it in time, the battery may enter the over-discharge protection at any time (the battery enters the over-discharge protection can effectively protect the battery cell, and the charger needs to be reactivated after the over-discharge protection).
- 3) The controller overheats (when the operating temperature exceeds 95°C, the vehicle will reduce the power and enter ECO mode, and if the continuous overheating exceeds 105°C, the power output will be cut off).
- 4) Motor overheating (when the operating temperature exceeds 130°C, the vehicle will reduce power and enter ECO mode, if the continuous overheating exceeds 150°C, the power output will be cut off.)

Operating Conditions

- ◆ At temperatures below 0°C, the battery is equivalent to 80% of its daily capacity. Sports gear is not recommended.
- ◆ When the temperature is higher than 40 °C, it is recommended not to ride at full power for a long time.

Water Exposure Guidelines

The key electrical components of 79BIKE off-road motorcycles are designed with full consideration of the waterproof requirements in the normal riding environment, the wading depth does not exceed 20cm, and can not soak in water for a long time, especially when the motor is at high temperature and cooled by water, the internal air shrinks, causing water absorption from the oil seal and cable to enter the interior, causing damage. The following are the waterproof levels of each component:

◆ Battery and motor: IP67

◆ Controller: IP67

◆ Full connector: IP55

7、 FAULT PHENOMENA AND TROUBLESHOOTING METHODS

Project	Fault cause	Elimination method
Turn on the power, the motor is not working	1.The battery cable is loose	1. Check whether the cable is securely connected 2. The plug is repaired and connected securely 3. Reconnect and tighten the maintenance office 4. Check the brake handle and brake switch
	2.The plug of the speed regulating adapter is loose or off	
	3.The motor cable is loose or falls off	
	4.The brake handle does not return or the brake switch is faulty	
The speed control fails or the maximum speed is low	1.Trigger the bike protection system	1. Restart the vehicle 2. Wait for the vehicle temperature to return to the normal working range 3. Check whether the brake, tipping, and side support power off switch cables and plugs are securely connected 4. Check whether the governor adapter cable is securely connected to the plug
	2.Trigger the temperature protection system	
	3.Trigger the power failure protection system	
	4.The speed controller is faulty	
Insufficient range on a single charge	1.Insufficient tire pressure	1. Fill your tires to the right air pressure. 2. Power up or check whether the charger plug is in bad contact. 3. Readjust the brake. 4. Replace the battery. 5. It is normal for the use environment to reduce the battery life.
	2.Insufficient charging or faulty charger	
	3.Improper braking adjustment and excessive driving resistance	
	4.The battery is aged or damaged	
	5.Many uphill, headwind, frequent acceleration and deceleration, heavy load	
Abnormal noise from the vehicle while driving	1.The tightness of the chain is unreasonable	1.Adjust the tightness of the two-stage transmission chain 2.Adjust the tightness of the first drive belt 3.Brake disc and brake shoe have foreign bodies to clean; The brake caliper is loose or improperly installed
	2.The tightness of the belt is unreasonable	
	3.The brake system is not installed properly	
Charger does not charge	1.The charger plug is off or the connection is loose	1. Insert the plug or connector. Open the battery compartment cover and insert the connector tightly. 2. Open the battery compartment cover and plug it tightly. 3. Activate the battery.
	2.The battery string cable plug is loose	
	3.Activate the overlaid battery	

Project	Fault cause	Elimination method
After connecting the power supply, the charger cannot work normally, and the meter has no power display	Battery overdischarge protection due to a long time without charging, or improper battery storage.	<ol style="list-style-type: none"> 1. Connect the output end of the charger to the battery port, and connect the input plug of the charger to the mains power grid. At this time, the indicator of the charger body blinked red and green alternately. 2. "Unplug-plug" charger and mains connection plug 1 time; At this time, the red light of the charger body blinks rapidly (at an interval of 0.5S) for 20S. 3. After 20S, the red indicator keeps on for 10S. During this 10S, "unplug" the charger and the AC network plug once. 4. The "forced charging" function of the charger starts, and the charger enters the normal charging process. <p>Note :a Do not insert or remove the AC plug in the 20S in Step 2; otherwise, you need to start again in Step 1. b. Remove and insert the AC plug in Step 3 within 10 seconds after the red light is on. Otherwise, you need to perform Step 1 again.</p>
Other faults	<ol style="list-style-type: none"> 1.When you encounter a fault that cannot be removed by yourself under the above guidance or a fault that cannot be determined 2.Motor, controller, charger, battery damaged 	If you encounter the above situation, please contact the supplier or maintenance station, do not open the above parts without authorization, otherwise you will lose the company's warranty commitment.

8、 MAINTENANCE GUIDE

Check content

1、 In principle, normal riding, you can do the first check at 10-300km (it can also be understood as the first guarantee).

- ◆ Chain tightness check.
 - ◆ Check the tightness of each screw in the handlebars.
- ◆ Front and rear steel wire spokes loosened.
 - ◆ Whether there is a gap in the front direction bowl group.
- ◆ Belt tightness check; (There may be some friction on the new leather belt, which can be removed by waxing on both sides of the belt, or it can be ignored, no impact.)
- ◆ Shock absorber adjustment, check whether oil leakage, compression and rebound damping are in the correct position; (Note: Do not turn the adjustment knob to the far left or the far right during adjustment)



Special attention: During the entire maintenance process, the whole vehicle cannot be powered on, that is, it cannot be operated in the starting state of the vehicle.

2、 Pay attention to safety during inspection

- ◆ Choose a wide, flat area and park your vehicle.
- ◆ When a driving check is required, it should be carried out in a safe place, while paying attention to the surrounding environment and conditions.
- ◆ If an anomaly is found through the inspection, please remove the anomaly before driving, if it is difficult to solve, please contact the after-sales service or the designated authorized service network.

Notice

- ◆ **The front and rear brakes are all disc brakes. When the brake friction lining is severely worn, the friction lining should be replaced.**
- ◆ **Pay attention to keep the disc brake system clean in daily use, avoid long-term adhesion of sediment, especially oil stains.**

Inspection of operating parts

◆ Check whether the shock absorber is bent, deformed or damaged

If the front shock absorber is damaged, loose, oil leakage and other faults, shake the handlebars up and down to check whether there is abnormal noise caused by the front shock absorber fault, if the front shock absorber is abnormal, please contact the after-sales service or designated authorized service network.

◆ Check of brake

Check whether the free clearance of the brake handle is within the specified range (15-30mm), and adjust it if it does not meet the requirements after measurement.

◆ Check the braking effect

Please drive at a low speed on a dry and flat road to check the braking effect of the front and rear brakes separately.

◆ Inspection of tires

The tires of the vehicle are in contact with the ground for a long time, and foreign objects such as stones, glass, and nails on the ground will cause damage to your tires, so you should pay attention to observe the road surface when driving and avoid driving where the tires may be damaged. In addition, it is necessary to regularly check whether the tire has obvious damage such as cracking, whether it has penetrated foreign bodies such as stones and glass, and there is no reasonable abnormal wear.

◆ Inspection of tires

The tires of the vehicle are in contact with the ground for a long time, and foreign objects such as stones, glass, and nails on the ground will cause damage to your tires, so you should pay attention to observe the road surface when driving and avoid driving where the tires may be damaged. In addition, it is necessary to regularly check whether the tire has obvious damage such as cracking, whether it has penetrated foreign bodies such as stones and glass, and there is no reasonable abnormal wear.

- 1) Check the depth of tire grooves.
- 2) Check whether the spokes of the rim are loose.
- 3) Check for cracks, damage, foreign bodies, abnormal wear.
- 4) Check the tension of the chain. Chain up and down 10-20mm.
- 5) In the cooling state of the tire, check the air pressure with the tire barometer.

- ◆ Check the tire wear, check the groove depth, and replace the tire when the wear amount reaches 2/3 of the convex block. When there is abnormal noise or shaking in the tire, please contact the after-sales service or designated authorized service network to check and repair.
- ◆ The recommended locking torque is 30N·m for the middle shaft, 40N·m for the rear axle nut, and the locking torque for the front axle screw depends on the front fork.

▲ Notice

- ◆ The belt tension has been adjusted by the manufacturer before leaving the factory, please do not adjust it privately.
- ◆ Hold the brake handle tightly. If the ideal braking effect is still not achieved, check the cleanliness of the disc. If it still cannot be solved, please contact after-sales service or designated authorized service outlets for inspection.

Battery inspection

◆ Checking battery level

The vehicle uses a sealed lithium ternary battery, to check the battery level, press the battery switch. The battery is fully charged when the battery LED is fully illuminated.

◆ Checking the battery appearance

If the battery is damaged, for example, the upper and lower seal covers and intermediate meters are damaged, which may cause water leakage after the seal fails, contact the after-sales service or the designated authorized service network.

▲ Notice

- ◆ Storage of batteries in winter, it is recommended to store indoor temperature conditions above 0°C, regularly check the electricity.
- ◆ Close the electric door lock, turn off the air switch to the left, and cover the sealant cap of the charging port before loading the battery.
- ◆ If the battery cannot be put into the battery compartment, do not forcibly operate it. Take out the battery and check whether the battery is stuck because of foreign objects.

Battery charging and charger usage

- 1) Check whether the charger input voltage is consistent with the grid voltage;
- 2) Users are forbidden to disassemble the battery themselves to avoid damage and danger;
- 3) The charger will automatically turn off after it is full, but try to avoid connecting the charger to the grid for a long time, the longest shall not exceed 6 hours;
- 4) When charging, the bike must use the charger of the original model and do not use other models of the charger, so as to avoid damage to the battery or danger;

Use and maintenance of motors and controllers

- 1) Regularly check if the fuse is loose.
- 2) Regularly check whether the motor screws are loose.
- 3) Don't drive in too deep water, so as not to affect the work of the motor.
- 4) Regularly check the motor and controller wiring for looseness and insulation conditions.

⚠ Notice

When the motor temperature or controller temperature is too high or the battery charge is too low, the vehicle will automatically reduce power operation, this is not a fault.



The whole vehicle should not be involved in water more than the center of the wheel, the motor may cause motor failure if the motor is soaked in water for a long period of time.

Replacement of fuses

If the vehicle's instruments, horn, and lamps still do not work after opening the air switch and door locks, the fuse may have blown, if you need to replace the fuse, please close the air switch first as follows: Open the battery compartment cover, close the air switch, and pull out the battery, you can see the fuse box in front of the air switch (the factory fuse box is wrapped with a circle of black insulating tape), open the fuse box.

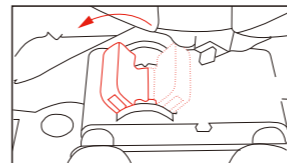

Close the air switch

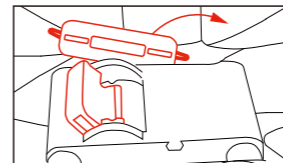

Find the white transparent fuse box

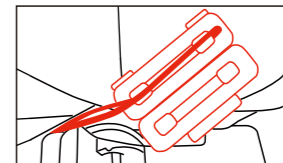

Open the fuse box and replace the spare fuse

⚠ Notice

- 1) Avoid strong water impact on the fuse area.
- 2) If the fuse blows again within a short period of time after replacing the fuse, check for reasons other than the fuse.
- 3) The fuse should be firmly inserted. If the insertion part is loose, it may cause the fuse to heat up, which may lead to other malfunctions and dangers.
- 4) Replacement of the fuse should be made with a fuse of the specified type and specification, and the use of a fuse that exceeds the specification may result in the failure of the protection function.

9、 DAILY USE INSTRUCTIONS

**Preventive maintenance and regular inspections reduce the risk of malfunction.
For additional services, please contact your 79BIKE dealer.**

1、 Recommended Maintenance Intervals

Extreme riding in harsh weather conditions or lack of cleaning can shorten maintenance intervals.

Maintenance Description	Interval
Remove dust and debris from the front fork	After each ride
Check air pressure and set sag	After each ride
Inspect the torque of front fork mounting bolts	After each ride
Remove the lower part, clean, and inspect bushings and seals; replace oil bath if necessary	Every 50 hours
Full front fork air spring service	Every 100 hours/1 year
Remove and clean the lower part, replace seals and bump rubber, and change oil bath	Every 100 hours/1 year
Full front fork shock maintenance	Every 100 hours/1 year

2、 Disposal

Please return your discarded 79BIKE products to a 79BIKE dealer for proper disposal.

10、 AFTER-SALES SERVICE AND WARRANTY SERVICE

Components	Warranty coverage	Warranty period
Motor assembly	Burnt coils, missing phases, demagnetization, short circuits, broken circuits, strange noises, broken hubs due to material reasons	12 months
Lithium battery	Lithium batteries in the specified use of the environment after charging (lithium battery rechargeable ambient temperature range of 0 °C ~ 35 °C, lithium battery use of the ambient temperature range of -10 ° ~ 45 °C. In the case of low temperatures, lithium battery capacity will have a different degree of decline, the specific degree of reference for -10 °C, the usable capacity of 70%, 0 °C at 85%, 25 °C at 100%) and not by external forces Shock, abnormal voltage, can not be charged, with a discharge meter to detect the capacity of less than 70% of the failure to give three packages (battery cycle three packages to replace the new battery date, according to the old battery three packages for the remaining date of the period)	
Controller, charger	Performance failure or quality problems occurred due to the product and cannot be repaired.	
Air switch, electric lock, main cable assembly, battery box lock, headlight, tail light, horn converter assembly.	Performance failure or quality problems occurred due to the product and cannot be repaired.	12 months
Brake Assembly	Oil leakage, unable to brake effectively (brake parts without brake pads)	
Front and rear shock absorber assembly	Oil leakage, no damping	
Dashboard, USB power supply, combination switch speed control center control	Failure of performance or quality due to the product cannot be repaired.	
Rear flat fork, steering handle tube, tailstock assembly, frame, steering column, foot straddle bracket, rear reduction linkage, rear rocker assembly, foot brace, sprocket, front and rear pulleys, footpeg assembly, center axle sleeve assembly, flat fork center axle, wheel rims, rear axle, front axle assembly, front and rear wheel hub assembly, electronic throttle, battery compartment cover.	Failure of performance or quality due to the product cannot be repaired.	No warranty
Bicycle bearings (excluding motor bearings), brakes, belts, chains, shock absorber oil seals, inner and outer tires, discs, brake skins, steering wrist assembly, fenders, handles, seat cushions, fuses, spokes, decorative parts, plastic parts, and other above items.	Wearable parts	

11、 AFTER-SALES SERVICE AND WARRANTY COVERAGE

Warranty rules

- ◆ The whole bike is guaranteed for 1 year: including the motor, controller, battery and charger, and other non-perishable parts; non-man-made damage to the performance of the failure, you can enjoy free maintenance, specific reference to this manual.
- ◆ If there is no quality problem, do not support the return and exchange. If a functional failure or quality problems occur, the company designated by the authorized service outlets to test and confirm that the quality of goods belonging to non-humans caused by the problem can choose to return or replace the goods.

Warranty start date

The date of the invoice and the date of the purchase certificate shall prevail for offline purchasers (calculated on the date of occurrence), and the date of the signing receipt for online purchasers (calculated on the day following the date of the customer's signing receipt). The delivery receipt and the purchase invoice are valid vouchers. If there are no vouchers, missing vouchers, or unclear smeared vouchers, the date of sale recorded by the system shall prevail.

12、 NON-WARRANTY COVERAGE

Sold products in the following cases, do not belong to the scope of free warranty services, users need to pay for maintenance.

- 1) Has been fully compensated by the insurance company.
- 2) Normal use of the process of reasonable wear and tear.
- 3) Exceeding the service period or scope stipulated in the instruction manual.
- 4) The user does not follow the provisions of this instruction manual for proper use, driving, and maintenance caused by product failure or damage.
- 5) Sold products due to rain, snow and ice soaking, smoke, drugs, chemicals, corrosion, and force majeure (including but not limited to earthquakes, typhoons, fires, floods, social events, mass events, violent crime, etc.) caused by failure or damage.
- 6) Users modify, dismantle and repair, and damage the product as a whole and parts of the normal state of use.
- 7) Users use non-original spare parts caused by parts damage or unauthorized changes in circuitry, line configuration.
- 8) The user can not provide a valid three packages of vouchers, or product formal invoices; vouchers or cards on the number do not match the product.
- 9) The user in the use of the process of collision, car crash, traffic accidents, overloading (the car for a single person, is strictly prohibited), speed, and other human factors caused by product failure or damage.
- 10) Extreme sports, in order to challenge the limit or speed for the purpose of quality problems arising from the warranty. Recommended vertical drop within 50cm
- 11) Improper use of the user's battery, placed for a long time (such as the entire car plugged in without turning off the empty open storage for more than a month, stored separately starting power less than 60% and more than 3 months), over-discharge, not timely charging or not timely and regular maintenance of the battery loss of under-voltage can not be repaired, or due to the appearance of the battery is damaged, the waterproof performance is damaged after the failure to repair in a timely manner still continue to use the battery, leading to damage to the circuit boards and cores after water ingestion.

15、PACKING LIST

Please carefully check whether the items in the packing box are complete and intact, if there are missing or broken or other problems, please contact the dealer or the manufacturer's after-sales department for consultation.

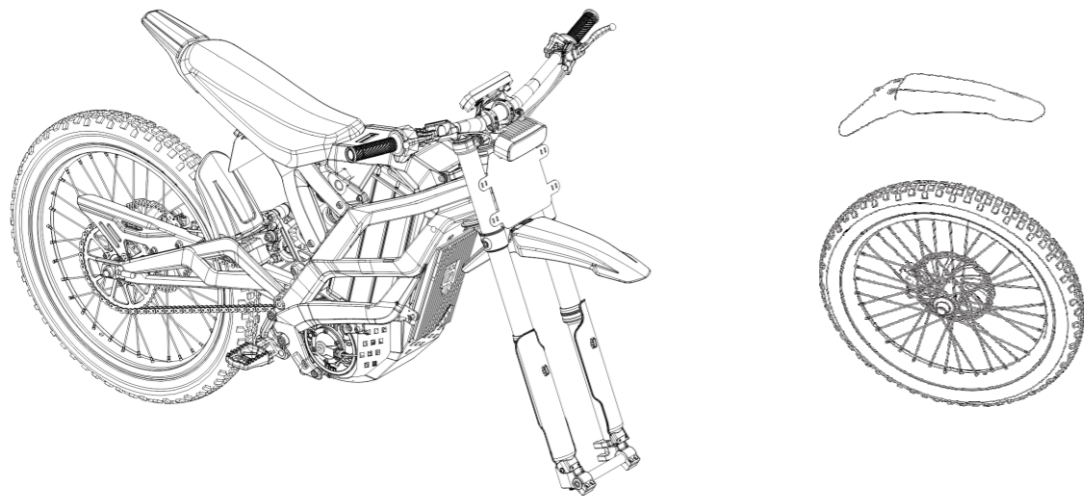

Instruction manuals & After-sales manuals



Front fender screws x3

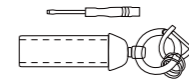

Dashboard keychain



Front fork reflectors



Keysx2

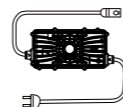

Charger



Footrest

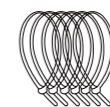

Black cable tiesx12



Multi-tool

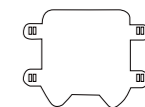

Front number plate

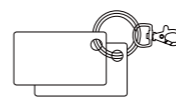

NFC cardsx2